

2,000VA
15-1,200 Hz

1Ø 0-150V_{L-N}
2Ø 0-300V_{L₁-L₂}
3Ø 0-150/260V_{L-L}



Standard Features:

- 1 phase / 3 phase Selectable Output from front panel or bus command
- 15 to 1,200 Hz. Operation – 5,000 Hz small signal bandwidth
- Precision Voltage Programming – 0.05% with Continuous Self-Calibration (CSC) engaged
- True-RMS metering of volts, amps, and power
- GPIB (IEEE-488.2) or RS-232 Interface
- Waveform Library – Arbitrary Waveform Generator
- 99 stored programs with associated transients for static and dynamic test applications
- UPC Studio Software Suite
- UPC Interactive LabVIEW™ Libraries

Available options:

- M99211- 3Ø, 0-312/540V_{L-L} external transformer assembly
- Rack enclosures with caster base
- Programmable Output Impedance
- Harmonic Analysis and Waveform Synthesis
- Peak Inrush Capture and Waveform Analysis
- UPC Test Manager Software Application

UPC Manager Software Suite

Master the Power of the Wave!

UPC Manager Software gives you the tools necessary to quickly and easily operate your AC Power Source. With our graphical interface control all areas of your AC Power Source testing with simple presets, user prompts, test sequences, test plans and custom reports.

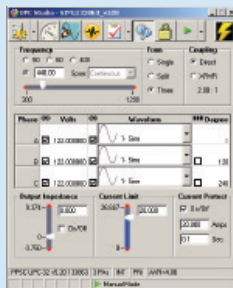

Model 320-ASX

As a member of Pacific's ASX-Series family of high performance AC Power Sources, the 320ASX offers the low acoustic noise, ease of installation, and maximum power density found in all of Pacific's high frequency, pulse width modulated AC Power Sources. Control and operational features provide a high degree of versatility and ease for applications ranging from simple, manually controlled frequency conversion to harmonic testing and sophisticated bus programmable transient simulation.

AC TEST POWER

The 320-ASX is equipped with a powerful micro-controller with the ability to operate as a fully integrated test system. It supplies a variety of power conditions and transients to the device under test while metering and analyzing all output performance parameters.

FREQUENCY/ VOLTAGE CONVERSION

The 320-ASX is an excellent source of stable AC Voltage over the frequency range of 15 to 1,200 Hz. The output frequency is quartz-crystal stabilized. Output voltages up to 300V are available.

PHASE CONVERSION

With the ability to provide single, two, and three-phase outputs, the 320ASX is an ideal choice to convert three-phase line voltage into precisely controlled split (two-phase) or single-phase output power.

UPC SERIES CONTROLLER

Three controller models are available offering both manual and programmable control. All controllers provide manual operation from the front panel. Programmable Controllers may be operated from the front panel or from a remote interface via RS 232 or GPIB.

The Leader in AC Power Technology

An early pioneer in the development solid-state power conversion equipment, Pacific Power Source continues to develop, manufacture, and market both linear and high-performance PWM AC Power Sources. Pacific's reputation as a market and technology leader is best demonstrated by its continuing investments in both research and development and world-wide customer support. With corporate owned offices in the United States, France, the United Kingdom, and China, local personalized support is always available.



THE POWER OF EXPERTISE

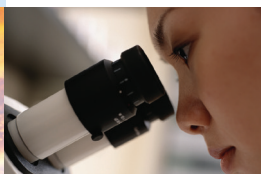

FREQUENCY CONVERSION

AEROSPACE

R & D

MILITARY

MANUFACTURING

CUSTOM



Телефон: +7 (499) 685-4444
info@4test.ru
www.4test.ru

Output Ratings

320ASX

Rated Power (VA) ¹	Coupling Mode	Form ²	Output Voltage ³ V _{rms} Max (L-N/L-L)	Current ⁴ (A _{rms})	Frequency Range	Input Power	Unit Height In/mm/U	Unit Weight (Lbs/Kg)
2000	Direct	1Ø/2Ø 3Ø	150/300 150/260	20/12 7/Ø	15-1200 15-1200	1Ø 47-63Hz	5.25/133/3U	85 Lbs/39 kgs

NOTES:

- Rated output power is based on a combination of nominal output voltage, rated current and load power factor. Values stated represent the maximum capabilities of a given model. Consult factory for assistance in determining specific unit capabilities as they might apply to your application.
- Unit is operable as single phase with dual range capability or as a three phase. Output voltage range and 1/3 conversions are selected by front panel or bus commands.
- V_{max} is output voltage with nominal input and full rated load applied.
- Available current will vary with output voltage and power factor.

ASX Power Source Specifications (PF = 1.0, V_{out} > 25% F.S.)

Output Frequency	Line Regulation	Load Regulation (Typ. 3 Phase)	Output Distortion	Ripple and Noise	Response Time
Full Power 15-1,200Hz Direct Coupled	0.1% max for a ±10% line change	3Ø direct coupled: 0.25% 15 to 400 Hz, 0.50% 400 to 1,200 Hz.	0.25% THD _{AVG} 15 to 200 Hz 1.25% THD _{AVG} 200 to 1,200 Hz	-66dB	60 µsec typical, 10-90% load step

Input Power Requirements (47-63 Hz)

Input Voltage	100V 1Ø ±10%	110V 1Ø ±10%	120V 1Ø ±10%	200V 1Ø ±10%	208V 1Ø ±10%	230V 1Ø ±10%	240V 1Ø ±10%
Input Current	22A _{rms}	20A _{rms}	18A _{rms}	10A _{rms}	10A _{rms}	9A _{rms}	9A _{rms}
Recommended Input service	25A	25A	25A	15A	15A	15A	15A

Power Factor Rating Curves

Rated Continuous load current as a function of Power Factor and Output Voltage-Nominal Input Line

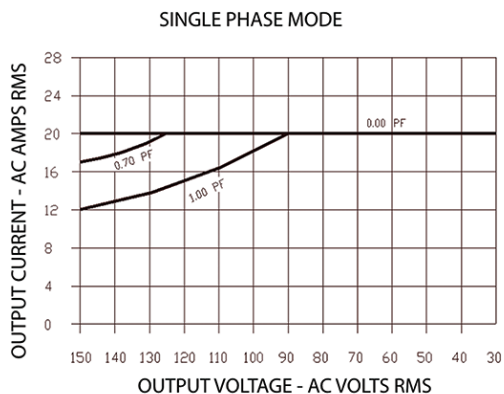

Short term overloads to 30 Amps are permitted. Operating time before thermal shutdown or circuit breaker trip varies from seconds to several minutes depending upon line and temperature conditions.

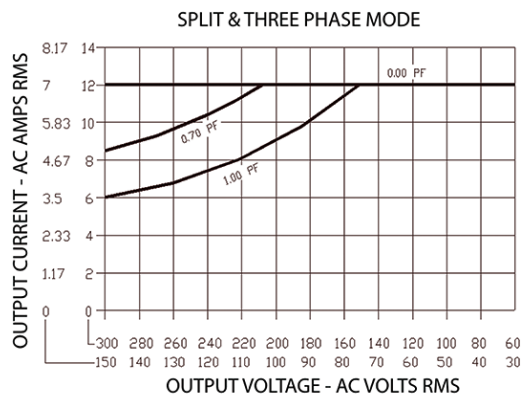

Short term overloads to 15 Amps are permitted. Operating time before thermal shutdown or circuit breaker trip varies from seconds to several minutes depending upon line and temperature conditions.

M99211 Transformer Option

Rated Power (VA)	Output Ratio	Nominal Output Voltage (L-N/L-L)	Current A _{rms} /Ø	Load Regulation (Typical)	Dimensions	Weight
2000	1.5:1 2.0:1 2.5:1	187/325 250/433 312/540	3 2.25 1.8	Varies from 2 to 5% depending on ratio. Improves to less than 0.1% with external sense and CSC enabled	3U 5.25 x 19 x 23 133mm x 483mm x 584mm	70 Lbs 32 Kg

When combined with the 320ASX, the M99211 external Transformer assembly provides an additional 3Ø, high voltage, output range. Three high performance, multi-tapped, autotransformers are assembled in a 19" rack-mount chassis and are configured with either a 1.5, 2.0, 2.5:1 step-up ratio (specified at time of order).

Refer to the adjacent table for rated output voltages and currents when supplied with a nominal, 125 V/Ø input signal. Complete M99211 modification description available on request. Additional current/voltage ranges available, consult factory.



M99211 Transformer Assembly Rear View

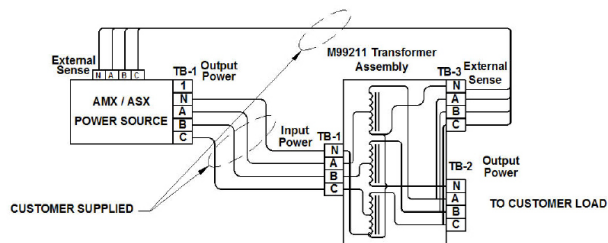

Total Control, Metering, and Analysis of AC Power - Simple, Intuitive Operation

The UPC Controller is a highly versatile one, two, or three phase oscillator/signal generator designed to control any of Pacific's AC Power Sources. Three controller models, UPC-3M, UPC-3, or UPC-32 are offered for use with the 320ASX.

Using the front panel keyboard and display, all controller models provide for selection of power source output mode, coupling, voltage, and frequency. Selecting the correct UPC controller for a given application varies with your test requirement, desired features, and price.

Both the UPC-3 and UPC-32 Controllers are available with either RS-232 or GPIB remote interface. Commands are structured in accordance with SCPI (Standard Commands for Programmable Instruments).

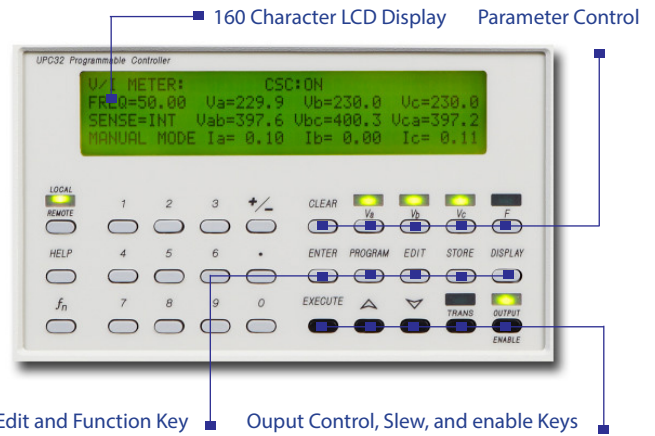

Program Edit and Function Key Output Control, Slew, and enable Keys

Controller Models

Features	UPC-3M	UPC-3	UPC-32
Output Modes	1Ø, 2Ø, & 3Ø	1Ø, 2Ø, & 3Ø	1Ø, 2Ø, & 3Ø
Waveform Library	Sine	Sine + 21 Editable	Sine + 15 Editable
Transient Functions	NO	YES, 50 Steps	YES, 99 Steps
Program Library	NO	99 Programs	99 Programs
Programmable Current Limit	YES	YES	YES
Programmable Current Protect	YES	YES	YES
Programmable Phase Angle	NO	YES, 0 to 359°	YES, 0 to 359°
CSC (Continuous Self-Calibration)	YES	YES	YES
Remote Interface	Std	NONE	GPIB
	Opt	NONE	RS-232
Waveform Synthesis/Analysis	NO	OPTIONAL	OPTIONAL
Prog. Output Impedance	NO	OPTIONAL	OPTIONAL
Inrush Peak Detect	NO	OPTIONAL	NO
DRM Link-Synchronization	NO	NO	OPTIONAL
Line Synchronization	NO	NO	OPTIONAL

Output Control Specifications

	UPC-3M/UPC-3	UPC-32
Frequency	Range	15-1,200Hz
	Resolution	4 Significant Digits
	Accuracy	±0.01% of full scale
Voltage	Range (l-n)	0 - 150/375
	Resolution	0.1V/ 0.5V
	Accuracy	0.5% of full scale (CSC Disabled) ±0.05% referenced to Internal Meter (CSC Enabled)
Phase Angle ØB and ØC relative to ØA	Range	0 - 359°
	Resolution	± 1°
	Accuracy	15.00 - 150Hz, ± 0.5° 15.00 - 300 Hz, ± 1° 15.00 - 600 Hz, ± 2° 15.00 - 1,200Hz, ± 3°
Current Limit	Range	1Ø = 0 - 300 Apk 3Ø = 0 - 100 Apk
	Resolution	0.05% F.S.
	Accuracy	±3% F.S. ±1% F.S.

(1) Full power output limited to 1,200 Hz in ASX models

External Inputs/Outputs

Analog Auxiliary Input	Each phase is algebraically summed with UPC waveform and amplified 25X to the direct coupled output. ±10Vpk (20Vpk-pk). One input per phase. $Z_{in} = 600 \Omega$
AM-Amplitude Modulation	±10 Vdc (20Vpk-pk) modulates the output voltage ±100% One input per phase. $Z_{in} = 600 \Omega$
Sync Outputs Zero Crossing	Positive Zero Crossing (0°) of Phase A analog output
Transient Trigger	Pulse at the start of a transient event. (UPC-32 only)
Transient Pedestal	TTL True when a transient is in progress
Output Clock	UPC-3, TTL level pulse rate varies with output frequency UPC-32, TTL level 1024 x output frequency

Waveform Control

Waveform Synthesis (/HAS Option)	Creates waveform by entering magnitude as % of fundamental and specified phase angle for 2nd through the 51st harmonic
Waveform Analysis (/HAS Option)	Reports waveform harmonic content and phase angle relative to the fundamental for the 2nd through the 51st harmonic as Total, Odd, and Even harmonic distortion

Output Metering

	UPC-3M/UPC-3	UPC-32
Voltmeter True V_{rms} each phase	Range	0-354 V _{l-n} , 708V _H
	Resolution	0.1 Vrms front panel, 0.001 Vrms via remote interface
	Accuracy	±0.2% F.S. plus Cal ref. 50-500Hz, ± 0.25% or rdg. ± 0.1% F.S. 20-5,000 Hz, ± 0.5% F.S.
Ammeter True A_{rms} and Apk each phase	Range	1Ø = 60 Apk, 3Ø = 20Apk
	Resolution	0.01 Arms or peak front panel, 0.001 Arms via remote interface
	Accuracy	±0.2% F.S. plus Cal ref. ±0.25% of rdg. 50-500Hz, ± 0.1% F.S. 20-5,000 Hz, ± 0.5% F.S.
Power Meter True Watts and Volt-Amps each phase	Range	1Ø = 21,240/Ø (W or VA), 3Ø = 7,080/Ø (W or VA)
	Resolution	1.0 Watt or VA to front panel, 0.001 W or VA via remote interface
	Accuracy	± 1% full range ±0.25% of rdg. plus 50-500Hz, ± 0.1% F.S. 20-5,000 Hz, ± 0.5% F.S.
Power Factor Ratio: kW_{mtr}/kVA_{mtr}	Resolution	Calculated and displayed to three digits following the decimal point.
	Accuracy	± 1% full range
Crest Factor Ratio: Apk/Arms	Resolution	Calculated and displayed to three digits following the decimal point.
	Accuracy	± 1% full range
Freq. Display	Range	15.00 - 1,200 Hz 20.00 - 5,000Hz
	Resolution	10.00-99.99 Hz, 0.01 Hz 100.0-999.9 Hz, 0.1 Hz 1,000-5,000 Hz, 1 Hz
	Accuracy	± 0.01% full range

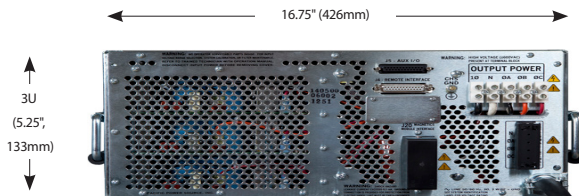

320ASX-UPC3 Power Source

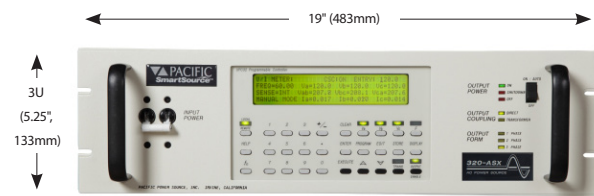

320ASX-UPC3 Power Source

General/Environmental

Temperature:	Operating: 0° to 55° C Storage: -10° to 70° C
Humidity:	0 - 95%, Non-condensing
Cooling:	Front and side forced air intake (200 CFM) with rear exhaust. Automatic Fan Speed Control for low acoustic noise and extended fan life.
Altitude:	Operating: 6,500 Ft (1,981 m) Storage: 40,000 Ft (12,192 m)
Heat Dissipation:	420BTU/ hr (Full kW Load)
Audible Noise:	Variable speed fans 65 dba Max @ 1 Meter
Agency Approvals:	Safety UL 61010 -1 EN 61010 -1 EMC EN 61326 -1

Protection and Safety

Hardware	Over-current, short circuit, over-temperature
Programmable Current Limit	A single RMS programmed, average responding, value provided for all phases. Limits current by reducing output voltage.
Programmable Current Protect	Allows the power source to operate in "constant voltage" mode, interrupting output when specified current protect limit is exceeded.

Mechanical Specifications

Height	320ASX: 3U (5.25", 133mm)
Depth	320ASX: 23" (584mm) (Approx. from front panel to the rear of chassis).
Weight	320ASX - 85lbs (39kg)
Mounting	Standard 19" rack (483mm). Cabinet options available.

Hardware Options

/M7073	Safety Interlock Normally Open Contacts
/M99413	Safety Interlock Normally Closed Contacts
M99211	2kVA, 3Ø, External Magnetics Module. Ordered as separate line item.
M99526	Input Current Soft Start Option
/MXXXXX	Other factory specified modification

Software/Firmware Options

/S	RS-232 Interface, 38.4 KBps (std UPC-3)
/G	GPIB Interface, IEEE-488.2, (std UPC-32)
/Prog-z	Programmable Output Impedance (not available with UPCxM)
/HAS	Harmonic Analysis and Synthesis (not available with UPCxM)
/IR	In-Rush Meter. Capture and view peak in-rush current values via front panel or remote interface (UPC-3 only).
Test MGR	UPC Test Manager License: Create, edit, and execute Test sequences and reports. Ordered as separate line item.
Test SEQ	Avionics test sequences; DO-160, ABD-0100, ABD-0100 (A350), Ordered as separate line item, Requires 'Test' Manager License.

Ordering Information

Model	Controller	Options	Input Voltage (V_{IN})
<input type="checkbox"/> 320ASX	<input type="checkbox"/> UPC3M <input type="checkbox"/> UPC3 <input type="checkbox"/> UPC32	See List Above	<input type="checkbox"/> 100V 1Ø ±10%, 47-63Hz <input type="checkbox"/> 110V 1Ø ±10%, 47-63Hz <input type="checkbox"/> 120V 1Ø ±10%, 47-63Hz <input type="checkbox"/> 200V 1Ø ±10%, 47-63Hz <input type="checkbox"/> 208V 1Ø ±10%, 47-63Hz <input type="checkbox"/> 220V 1Ø ±10%, 47-63Hz <input type="checkbox"/> 230V 1Ø ±10%, 47-63Hz <input type="checkbox"/> 240V 1Ø ±10%, 47-63Hz

Order Example

320ASX-UPC3/G, V_{IN} = 230V, 1Ø

- 2 kVA, 3-Phase, AC Power Source with UPC-3 programmable controller.
- Optional GPIB Interface
- 230V-L-N, 1 Phase Input Voltage

Typical Delivery Items

- AC Power Source
- English Manuals (AC Source and Controller)
- UPC Studio Software - (Download)
- UPC Interactive LabVIEW™ Libraries (Download)
- Compliance Certificate with Test data
- CE Conformity Document (CE Models)

Available Models

With Manual Controller

320ASX-UPC3M

With Programmable Controller

320ASX-UPC3

320ASX-UPC32



PACIFIC
POWER SOURCE



ООО «4ТЕСТ»
Телефон: +7 (499) 685-4444
info@4test.ru
www.4test.ru